

A4 OpPO P/N 9770317

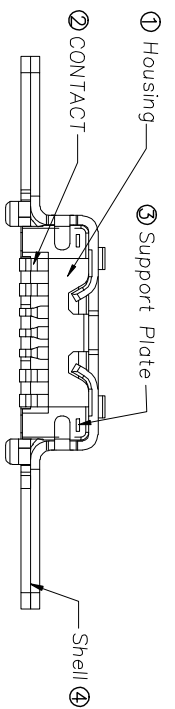
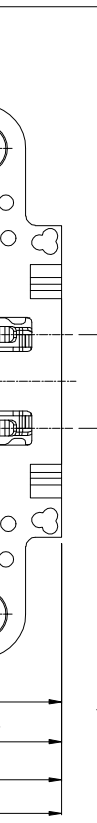
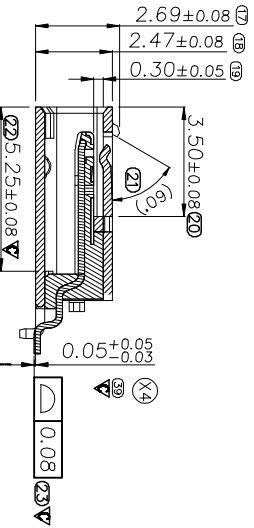
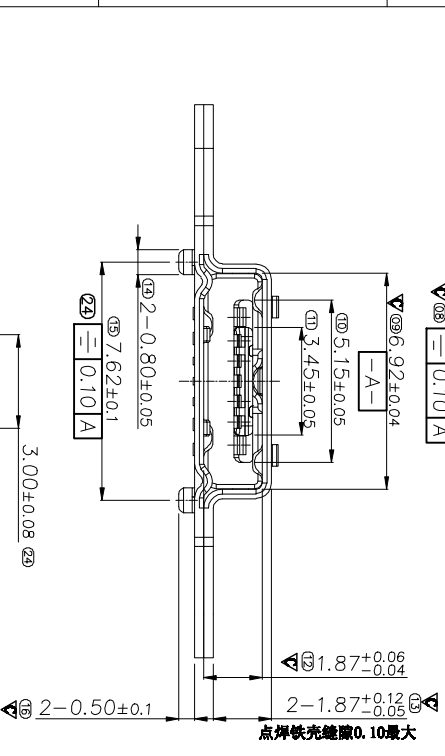
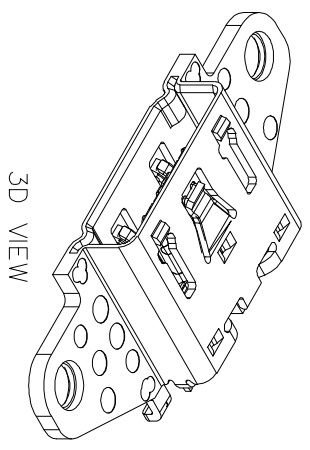
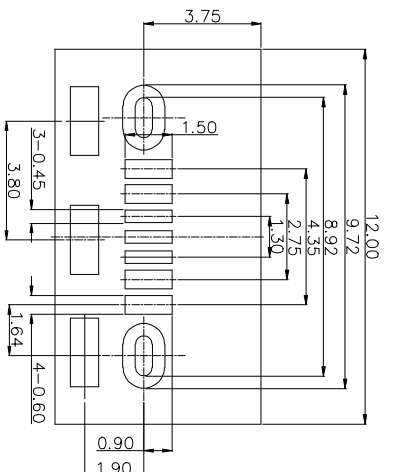
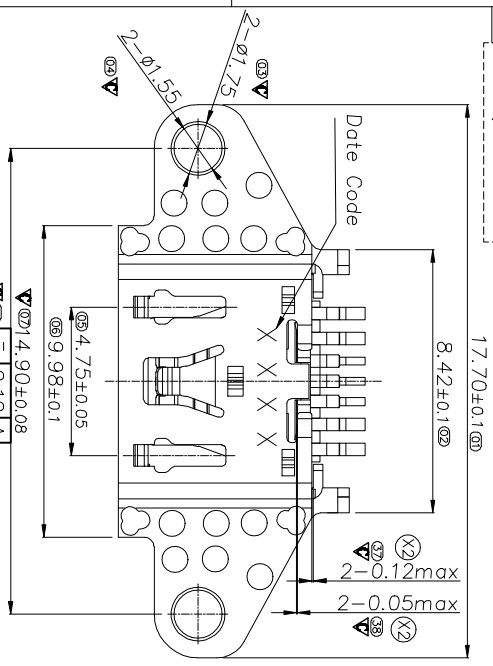

- 说明:**
- NOTE:**
1. 塑胶材料: PA10T, 颜色: BLACK;  
HOUSING MATERIAL: PA10T, COLOR: BLACK;  
端子材料: 铜锡50"120U", 接触区镀金30U", 焊脚面镀金2A", 反面1U";  
CONTACT MATERIAL: NICKEL AND COPPER;  
NICKEL 50~120U" UNDER PLATED OVER ALL;  
30U" MIN. GOLD PLATED AT CONTACT AREA;  
⑤ 2U" MIN. REVERSE 1U" GOLD PLATED AT PLATED AT SOLDER TAIL AREA;  
铜片材料: 不锈钢, 镀镍50"120U";  
SUPPORT PLATE MATERIAL: STAINLESS STEEL, PLATED NICKEL 50~120U";  
外壳材料: 不锈钢, 镀镍50"120U"; 镀上镀厚镍80"160U";  
SHELL MATERIAL: STAINLESS STEEL,  
NICKEL 50~120U" UNDER PLATED OVER ALL;  
MATE TIN 80~150U" ON THE ALL.
  2. 产线性能:  
2.1. 耐电压: 使用交流电压100V, 电流1mA, 保持1分钟;  
Applied AC 100V for 1 minute 1mA;  
2.2. 接触电阻: 4mΩ Max;  
CONTACT RESISTANCE: 40mΩHM Max;  
2.3. 绝缘电阻: 100MΩ Min;  
INSULATION RESISTANCE: 100MOHM Min.  
2.4. 拔出力: 插入力加最大, 拔出力加最小;  
MATING FORCE: 25N Max, UNMATING FORC 10N Min.  
2.5. 使用寿命: 10000次;  
DURABILITY: 10000 CYCLES  
3. 标注▽的为重点尺寸; 标注ⓐ的寸为MIL标准量之尺寸;  
MARK ▽ THE KEY SIZE. MARK ⓐFAI.

EXTEND USE		TITLE	
GENERAL TOLERANCE	ANGLES	UNIT	MICRO USB CONNECTOR MANUFACTURER DRAWING
④	±.3°	mm	C-3.089A4
③	±0.30		
②	±0.20		
①	±0.15		
ITEM	±.00		
PART NAME		FINISHED	DRN
MATERIAL		DRN	在 杰 2017.06.27

ITEM	PART NAME	MATERIAL
④	SHELL	SUS301
③	SUPPORT PLATE	SUS301
②	CONTACT	C7025
①	HOUSING	PA10T
ITEM	PART NAME	MATERIAL

